

**1**

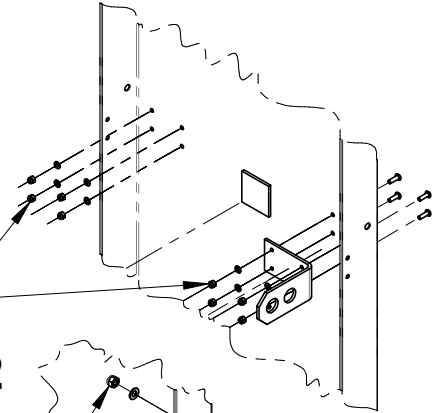

**1.1**



**1.2**

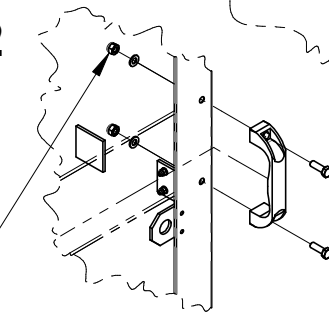

**2**

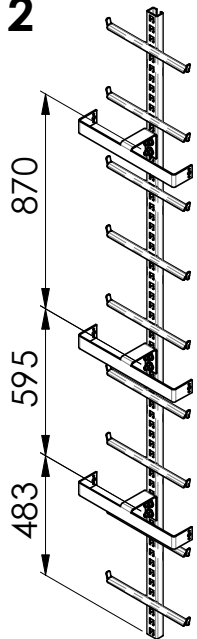

**2.1**

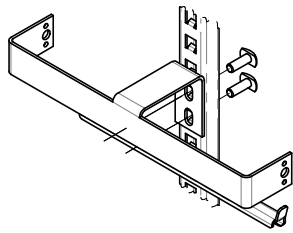

**2.2**

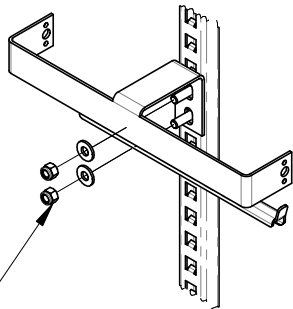

50 N·m

**3**

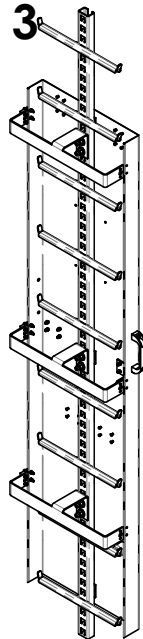

**3.1**

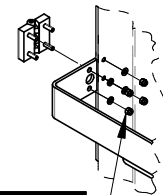

**4a**

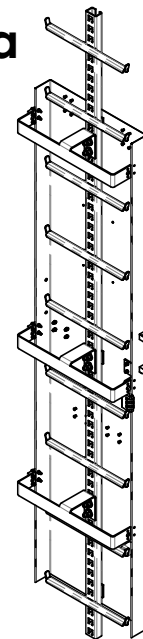

**4b**

